



LADYBIRD CRANE HIRE

IGO 36

SUPPLIERS OF PEDESTRIAN OPERATED SELF-ERECTING TOWER & CITY CRANES

Crane Specifications

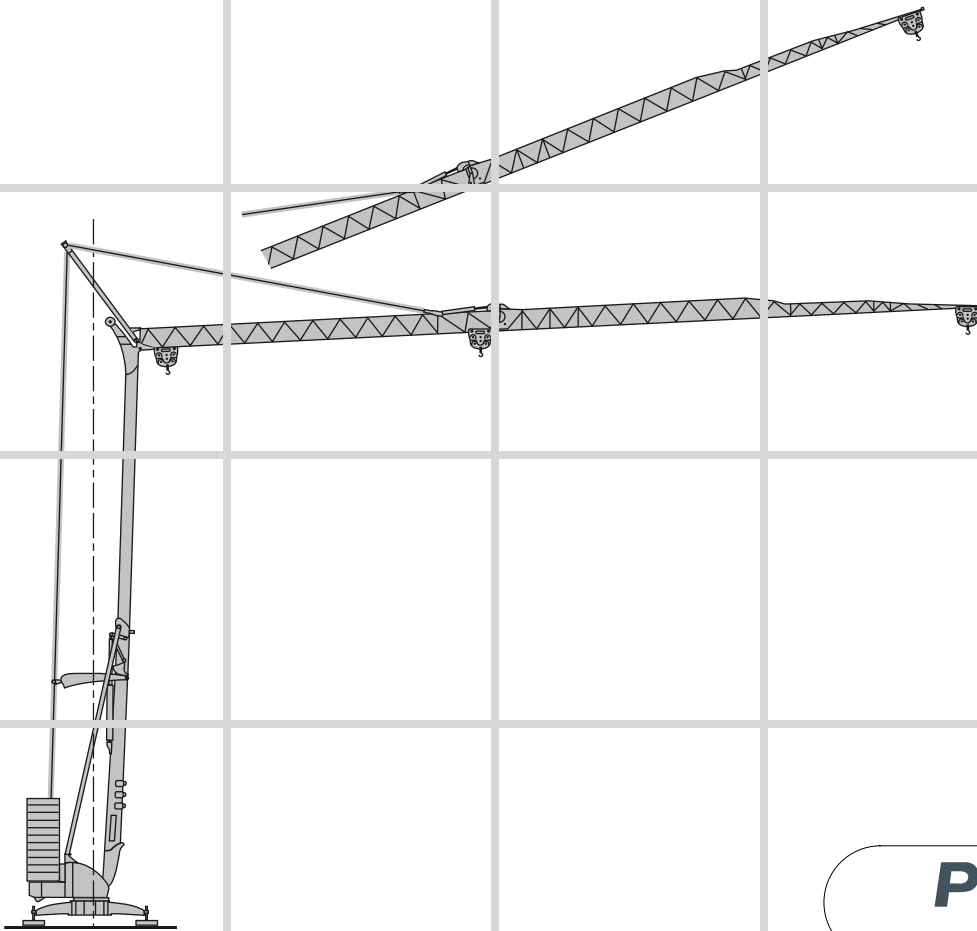

POTAIN
by Manitowoc

LADYBIRD CRANE HIRE

LADYBIRD HOUSE
BROCKHILL YARD
HEWELL LANE
REDDITCH
B97 6QT

t: 01527 889 889

f: 01527 889 879

e: info@ladybirdcranehire.co.uk

w: www.ladybirdcranehire.co.uk



32m Self-Erecting Crane

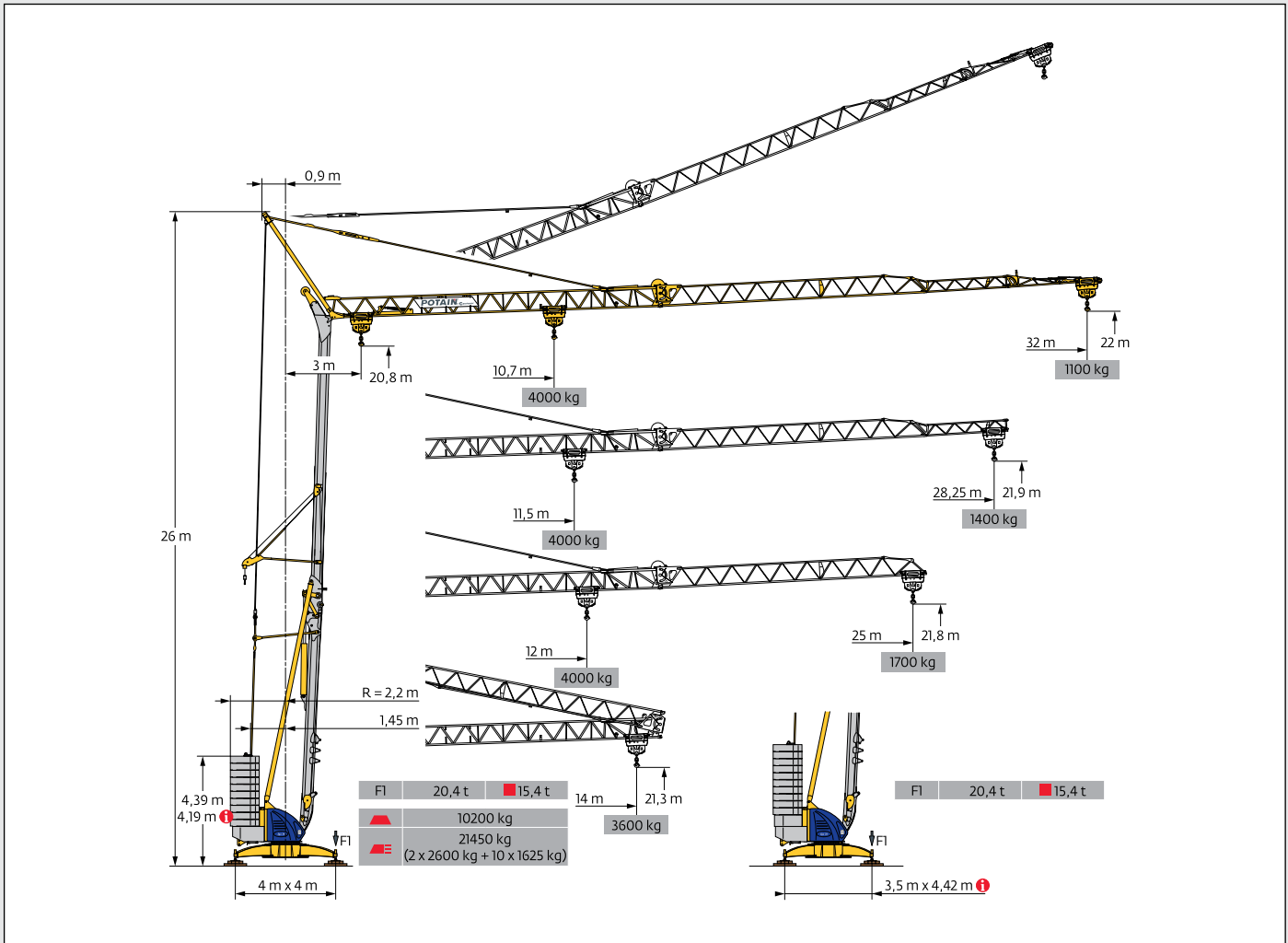

Load Diagrams

Jib Length (m)	Counterweight (kg)	Capacity (kg)	Capacity (t)
32	4000	3600	3.6
28.25	4000	1400	1.4
25	4000	1700	1.7
14	3600	3600	3.6





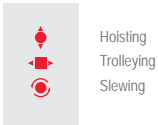

Capacity (kg)	Capacity (t)	Radius (m)
4000	4	12.87
3870	3.87	13
3460	3.46	13
3125	3.125	13
2845	2.845	13
2610	2.61	13
2410	2.41	13
2230	2.23	13
2080	2.08	13
2000	2	13
1940	1.94	13
1880	1.88	13
1820	1.82	13
1615	1.615	13
1375	1.375	13
1250	1.25	13
1090	1.09	13
1000	1	13

Specifications and data not binding. Subject to modification without notice



Mechanisms



												ch - PS hp	kW	
	15 LVF 10 Optima	m/min	3,6	18	30	54	66	1,8	9	15	27	33	15	11
		kg	2000	2000	2000	1000	500	4000	4000	4000	2000	1000		
	3 DVF 5	m/min	15 - 30 - 41										3	2,2
	RVF 41 Optima+	tr/min U/min rpm	0 → 0,8										4	3
														
400 V (+10% -10%) 50 Hz 480 V (+6% -10%) 60 Hz						18 kVA								

Erection

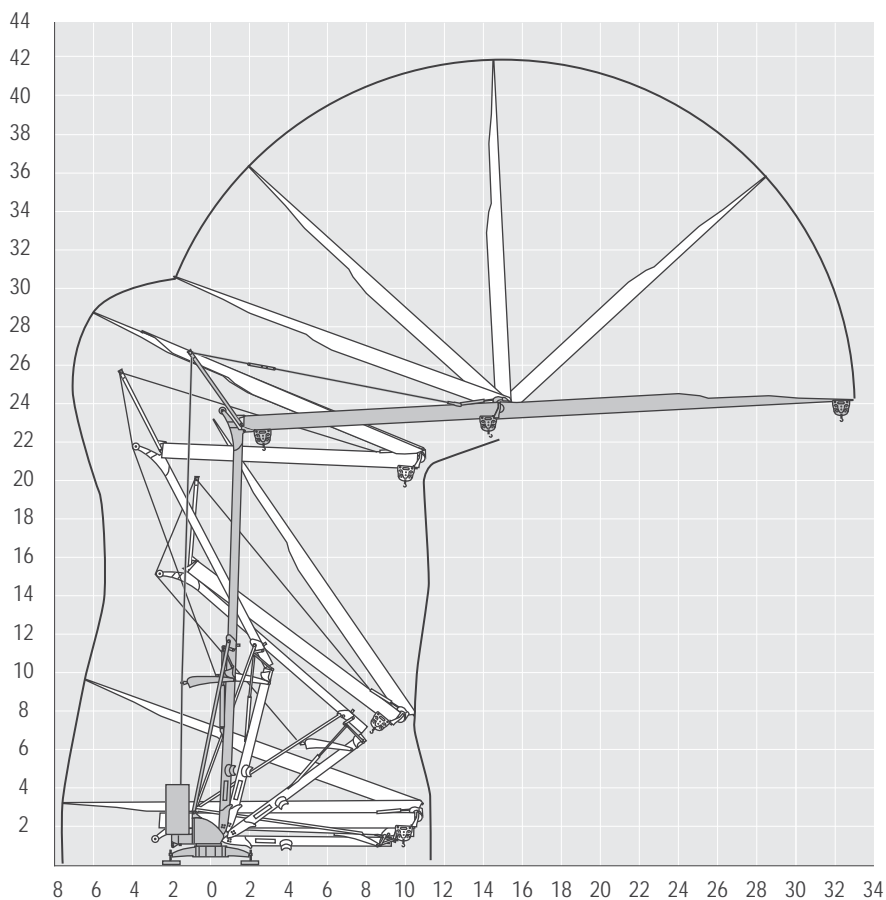

Specifications and data not binding. Subject to modification without notice