



LADYBIRD CRANE HIRE

IGO 42

SUPPLIERS OF PEDESTRIAN OPERATED SELF-ERECTING TOWER & CITY CRANES

Crane Specifications

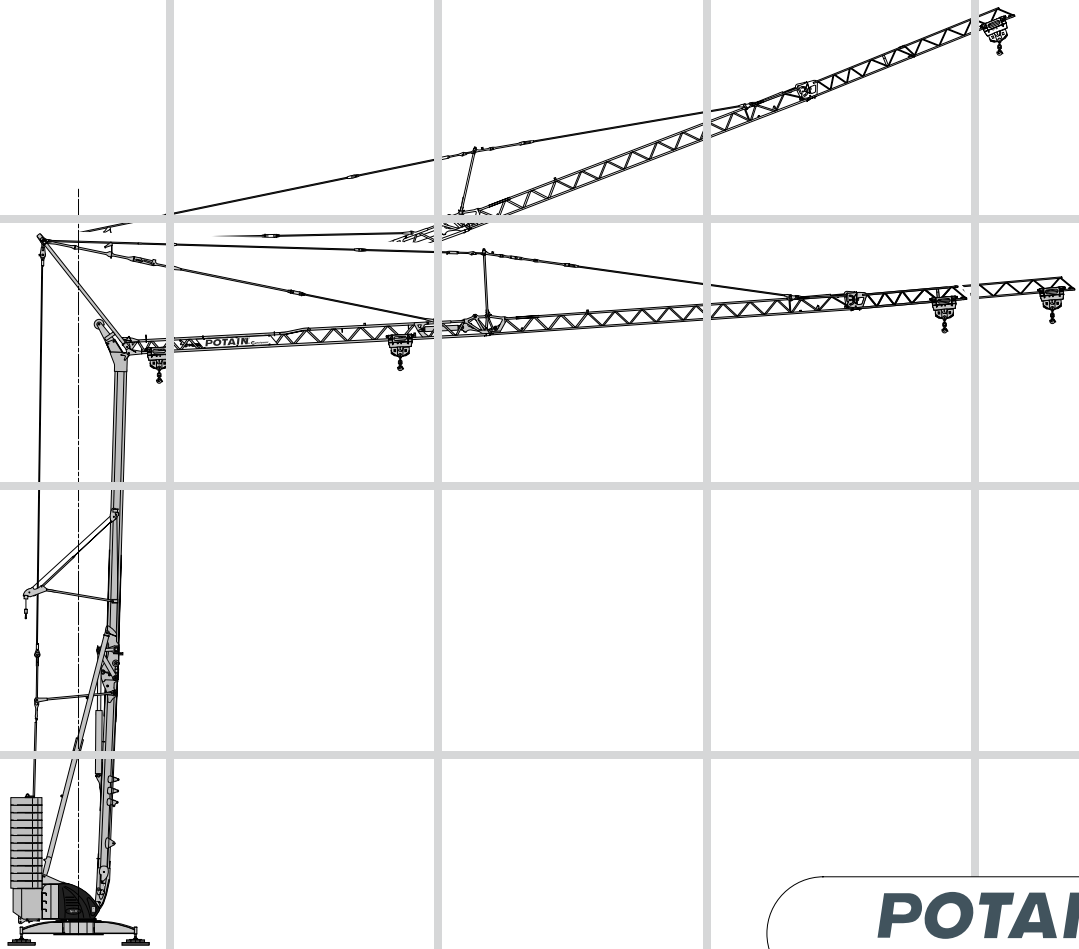

POTAIN
by Manitowoc

LADYBIRD CRANE HIRE

LADYBIRD HOUSE
BROCKHILL YARD
HEWELL LANE
REDDITCH
B97 6QT

t: 01527 889 889

f: 01527 889 879



e: info@ladybirdcranehire.co.uk



w: www.ladybirdcranehire.co.uk



Mechanisms

400 V - 50 Hz 480 V - 60 Hz		↑					↑					ch	PS
↑	15 LVF 10	3,6	18	30	54	66	1,8	9	15	27	33	15	11
		2000	2000	2000	1000	500	4000	4000	4000	2000	1000		
↔	3 DVF 5	15 - 30 - 45 (0 1000 kg) 15 - 30 - 41 (1000 4000 kg)										3	2,2
⊙	RVF 41	0 0,8										2	3

-  Hoisting
-  Trolleying
-  Slewing

 IEC 60204-32	 kVA
400 V (+10% -10%) 50 Hz 480 V (+6% -10%) 60 Hz	15 kVA

Erection

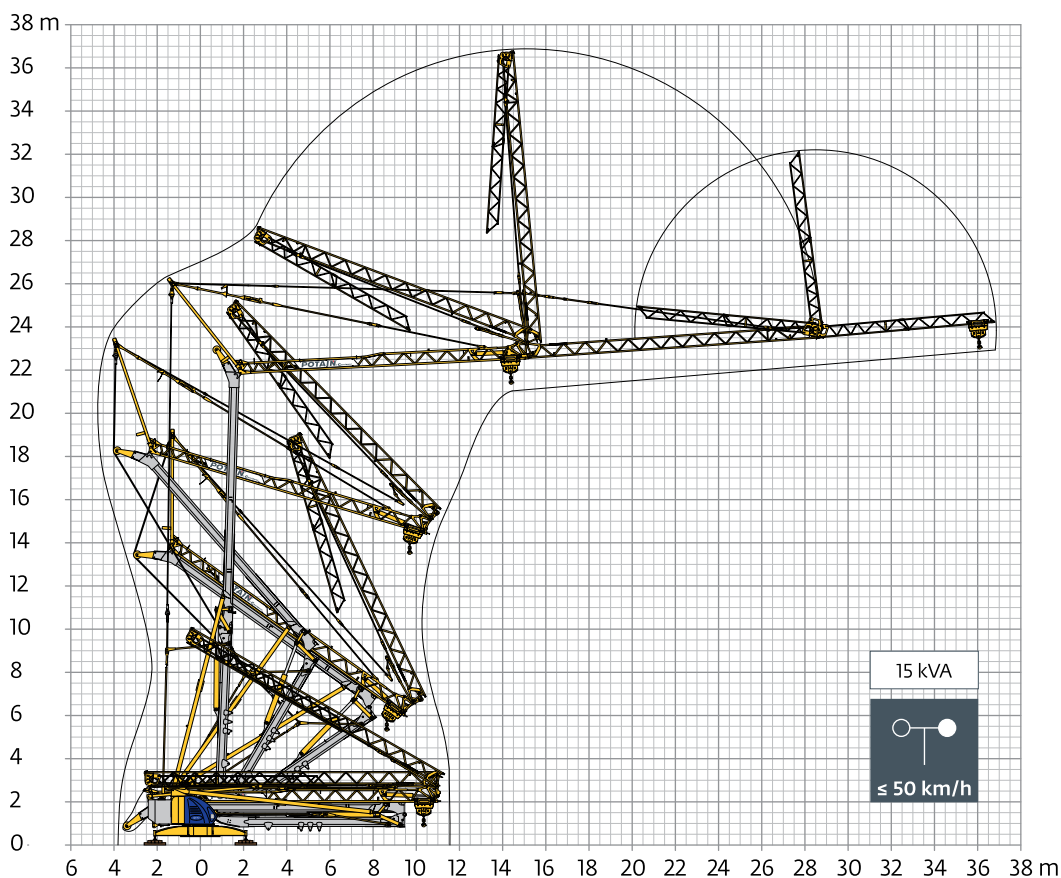

Specifications and data not binding. Subject to modification without notice